

## GA 4000AC

自动空气辅助喷枪 AUTOMATIC AIRCOAT GUN



- ☒ 喷涂质量卓越 Excellent finishing quality
- ☒ 结构超轻紧凑 Ultra light and compact
- ☒ 操作可靠性高 High process reliability

# 瓦格纳空气辅助喷涂喷枪：用于高质量表面完美喷涂 WAGNER AirCoat - Perfect finishing for high quality surfaces

## 瓦格纳空气辅助喷涂技术

空气辅助喷涂由无气喷涂和空气喷涂两种喷涂方式组合而成。吸取了这两种技术组合所具备的优点：例如卓越的雾化，高传递效率，可调喷幅，而且适用大规模喷涂应用。

油漆首先在高压无气状态下雾化。这项方法的优点是喷涂速度快，高传递效率和雾化优异。高传递效率可降低油漆消耗量并且符合VOC排放标准。

雾化液体再通过空气喷涂雾，喷涂质量更加优异，并且可以调节喷幅宽度。

## WAGNER AirCoat Technology

AirCoat atomisation is composed of airless and air atomisation processes. This combines the advantages of both technologies such as excellent atomisation, high transfer efficiency, soft edges, adjustable spray with and high application speed.

The material is first atomized in an airless process. The advantages of this method include high application speed, high transfer efficiency and a good atomisation. A high transfer efficiency reduces the paint consumption and are in line with the VOC regulations.

The air spray atomisation then softly atomizes the material a second time to bring the finishing result to an excellent quality and provides the possibility of adjusting the fan width.

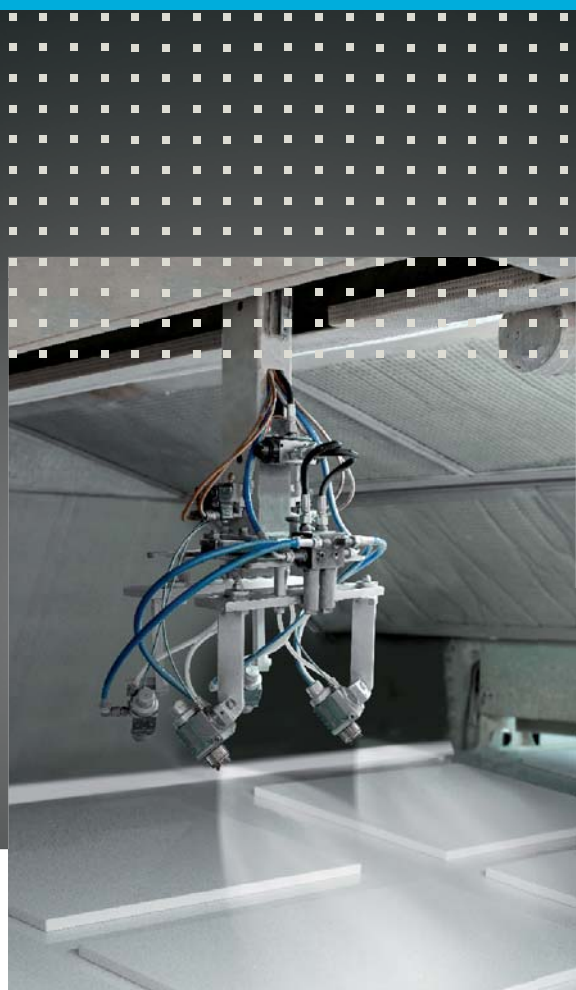

## GA4000AC技术

创新的瓦格纳自动空气辅助喷枪采用新的空气辅助雾化过程，产生最好的喷涂效果。此枪满足所有市场需求—灵活性最高，超轻，尺寸小巧和最新长寿命维修包提高了生产过程可靠性。

## GA 4000AC technology

The innovative WAGNER automatic AirCoat guns employ our brand new AirCoat atomization process to produce the finest finishing results ever. These guns meet all market demands - highest flexibility, ultra light weight, compact dimensions and new long life packing for a high process reliability.

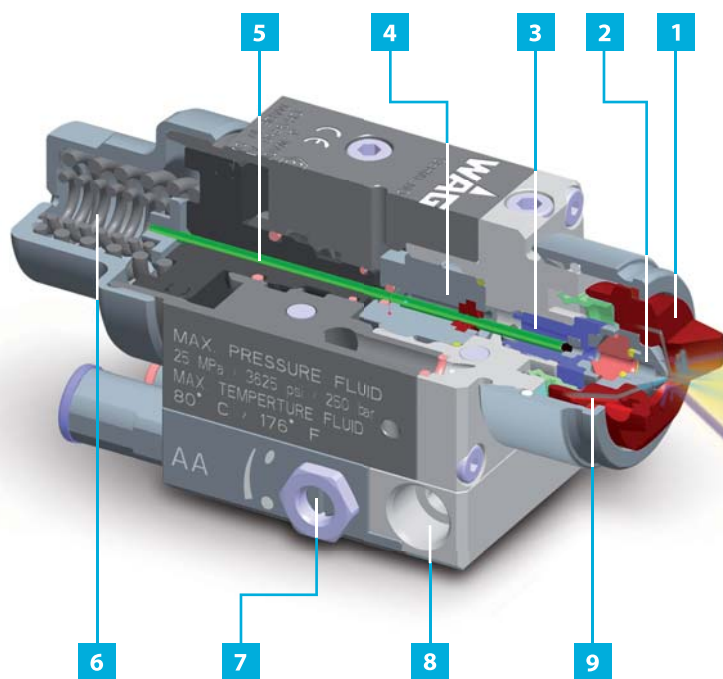

- 1 空气帽 Aircap
- 2 喷嘴 High quality nozzle
- 3 碳化钨基座阀  
Valve with tungsten carbide seat
- 4 耐用维修包 Long life packing cartridge
- 5 枪针（耐摩擦特殊处理）  
Needle (special treatment to reduce wearing)
- 6 驱动装置（柱塞和弹簧）  
Drive (Piston and spring)
- 7 内部控制调节 Internal control adjustment
- 8 液体通道 Material connection
- 9 空气通道 Air passages

# 巨大优势

## Great advantages for your business

### GA4000AC

### 设计满足您的需要

### GA 4000AC:

### Designed for your needs



Wood finishing



金属防腐表面喷涂 Metal protection & finishing



皮革表面喷涂 Leather finishing



### 主要应用领域

无论是用于木器喷涂用油漆，金属防腐蚀防护的双组份油漆，或者皮革喷涂的底漆，新GA4000AC枪完全满足您的所需！

- 木器和家具行业
- 防腐蚀防护应用
- 金属行业
- 皮革行业

### TYPICAL APPLICATIONS

Whether laquers for wood finishing, 2K materials for corrosion protection of metals or primers for leather coatings, the new GA 4000AC is perfect for your individual needs!

- ☒ Wood and furniture industry
- ☒ Corrosion protection
- ☒ General metal industry
- ☒ Leather coating

### 应用涂料

- 色漆，清漆，面漆
- 溶剂型漆和水性漆
- PU和聚氨酯漆
- 高固含量漆
- UV漆

### TYPICAL FLUIDS

- ☒ Stains, varnishes and laquers
- ☒ Solvent- and waterbased paints
- ☒ PU and Epoxy materials
- ☒ 2K materials
- ☒ High solid materials
- ☒ UV paints



# GA4000AC：新一代自动空气辅助喷枪

## GA 4000AC - A new generation of automatic AirCoat guns

### GA4000AC： 决定性优势！

历经改革的自动喷涂过程包括出色的喷涂质量和利用效率，提供最好的表面质量和高效的喷涂过程。

- 1 开关速度快速持续**  
开关速度快速持续能降低过喷以及在调整更为精确的开关位置。
- 2 最小和最轻的枪体**  
GA4000AC是市场上最小和最轻的自动空气辅助喷枪，能灵活固定，快速移动。

### GA 4000AC： crucial advantages!

Revolutionizing the automatic coating processes with excellent finishing quality and transfer efficiencies resulting in the best surfaces and in an efficient coating process.

- 1 Fast and constant open-close speed**  
Fast trigger speed reduces overspray due to closer and more precise trigger positions to the workpiece.
- 2 Smallest and lightest gun**  
The GA 4000AC is the smallest and lightest automatic AirCoat gun on the market. This provides for mounting flexibility and fast movement.



- 3 油漆应用范围广**  
所有的浸液部件都是不锈钢材料。因此适用于任何一种油漆。
- 4 最好的雾化**  
新型空气辅助雾化可产生更软和更流畅的喷涂外形。由于新的空气帽设计，降低了油漆压力，喷涂形状更加均匀。
- 5 高利用率**  
雾化优异轻柔，均匀的喷涂颗粒保证极高的利用率。
- 6 寿命长**  
新的长寿命密封圈增加了生产过程的可靠性同时降低了停机的几率。创新的开关模块系统使更换密封圈既简单快
- 7 固定装置**  
底座保持位置固定，所有的设置可用于多次喷涂。

- 3 Wide range of paints**  
All wetted parts are in stainless steel. So the gun is suitable for virtually any kind of paint.
- 4 Best atomization**  
The new AirCoat atomization provides a softer and smoother spray pattern. Due to the new air cap design, the material pressure is reduced and the spray pattern becomes more homogenous.
- 5 High transfer efficiency**  
The fine and soft atomization combined with a homogenous particle size guarantees a high transfer efficiency.
- 6 Long lifetime**  
The new long life packing increases the process reliability and reduces the downtime. With the innovative cartridge system, the changing of the packing is simplified and takes only minutes!
- 7 Fixed settings**  
The base plate system maintains the position and all setting for reproducible spraying results.

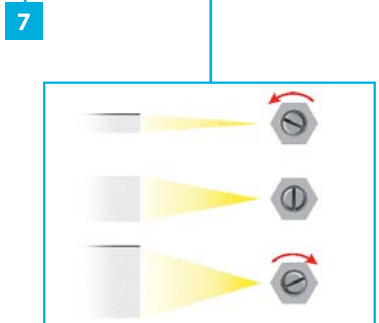

**扇形调节**  
可以调节扇形空气来控制扇形的宽度。

**Fan adjustment**  
Fan air can be adjusted to control the pattern width.

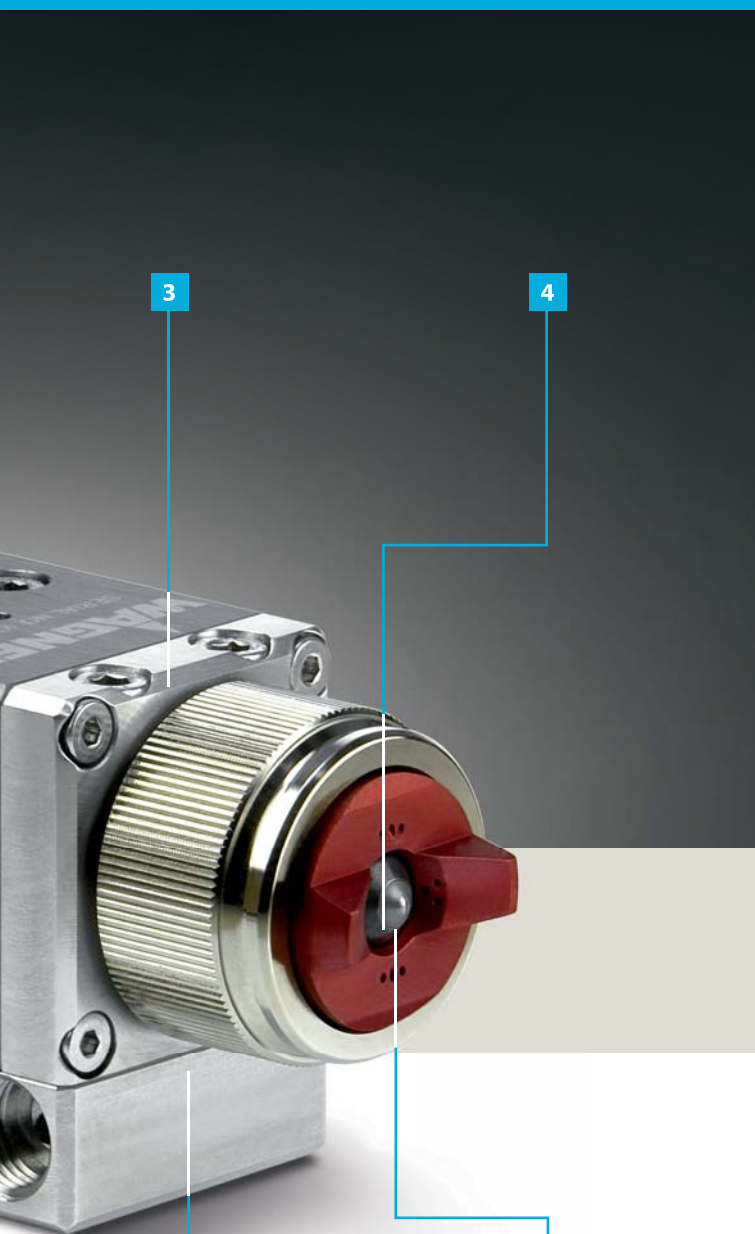

最好的雾化 Best atomization ever

### 瓦格纳空气辅助技术 WAGNER AirCoat

超过30年历史的空气辅助技术带给客户最新雾化系统，包括创新设计喷嘴和空气帽。

More than 30 years of experience in AirCoat technology has led to our newest design innovation in atomisation system consisting of nozzles and air caps

### 高压无气雾化 AIRLESS ATOMISATION

高质量特殊设计的空气辅助喷嘴具有最好的雾化和使用寿命，均匀输送液体，产生完美的喷涂效果。喷涂形状的柔合完美，喷涂轨迹重叠均匀，膜厚统一。

The specially designed high quality AirCoat nozzle provides the best atomisation and lifetime while distributing the material in a uniform pattern to create a perfect finishing result. Soft edges of the spray pattern allow a overlapping of spay tracks while achieving a uniform layer thickness.

### 空气喷涂雾化 AIRSPRAY ATOMISATION

借助柔和的辅助空气，更加提高了雾化质量。此外可以精确调节扇形宽度，同时保证空气帽可以在生产环境差的情况下保持干净。

The airspray atomisation further increases the quality of the atomisation with a soft airflow. Additionally enabling a precise fan width adjustment and keeping the air cap clean even in rough production environments.

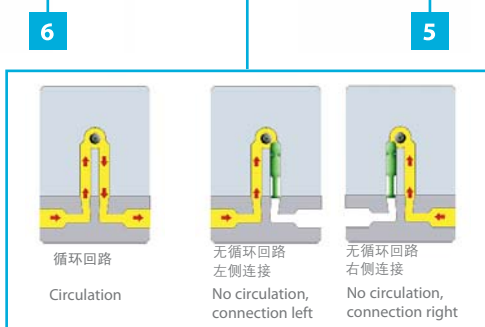

#### 液体流路

油漆可以在喷枪借助专用插头内循环或非循环运行，油漆接口可安装在侧面或后面，应用灵活。

#### Material flow

By using a simple lock pin the same baseplate is capable of standard feeding or circulation to the needle in both side or rear connections.

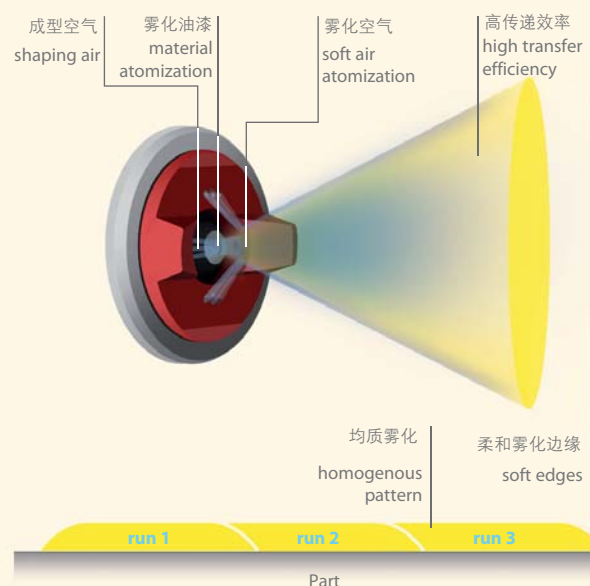

# GA4000AC 型号广泛

## GA 4000AC the complete range

### 安装组件应用灵活

GA4000AC由一个完整模块化系统组成。多种型号的喷嘴和空气帽，带万用接头的底板和数量广泛的紧固装置合成一个完美的解决方案，可以用于您的特殊应用。

### Accessories for highest flexibility

The GA 4000AC is build up in a complete modular system. A wide variety of nozzels and aircaps, baseplates with versatile connections and a large range of mounting equipment makes the GA 4000AC an ideal solution suitable for your specific application.



- 1 喷嘴**  
型号广泛的扁喷嘴和圆喷嘴
- 2 空气帽**  
红色空气帽-用于低粘度油漆  
蓝色空气帽-用于高粘度油漆  
棕色空气帽-用于快速清洗-无喷嘴调节
- 3 插销**  
使用插销能选择油漆循环或非循环
- 4 密封模块**  
模块中新的密封装置，提供快捷和快速的服务
- 5 底座**  
底座具有侧面与后部接口，以及一个机器人底座  
确保最大应用灵活性
- 6 固定装置**  
不同枪托和适配器用于每种应用设备，可灵活固定枪

- 1 Nozzles**  
Wide range of flat (ACF)- and round (ACR) spray nozzles for perfect finishing results.
- 2 Aircaps**  
Red - for low viscose materials.  
Blue - for high viscose materials.  
Bronze - for easy cleaning - no fan air adjustment
- 3 Lock pin**  
The lock pin provides the freedom to choose between circulation and no circulation.
- 4 Packing cartridge**  
New long life packing in a cartridge system for easy and fast service.
- 5 Base plates**  
Base plates with side / rear connections and a robot base plate ensure maximum flexibility.
- 6 Mounting devices**  
Different gun holders and adapters for each application provide a great flexibility in mounting the gun.



# 根据应用选择正确的自动空气辅助喷枪

## The right automatic AirCoat gun for your purpose

### 选择您的空气辅助喷枪

瓦格纳提供两种不同型号的自动空气辅助喷枪

**内部控制 (IC) 版本**  
底座上的一个调节螺丝可以轻松调节喷涂形状

**外部控制 (EC) 版本**  
喷涂形状可以使用外部控制阀进行调节

### Select your AirCoat gun

WAGNER offers two different versions of automatic AirCoat guns.

**Internal controlled (IC) version**  
Easy adjustment of the spray pattern by an adjusting screw in the base plate.

**External controlled (EC) version**  
Pattern can be adjusted from the outside with a remote valve.

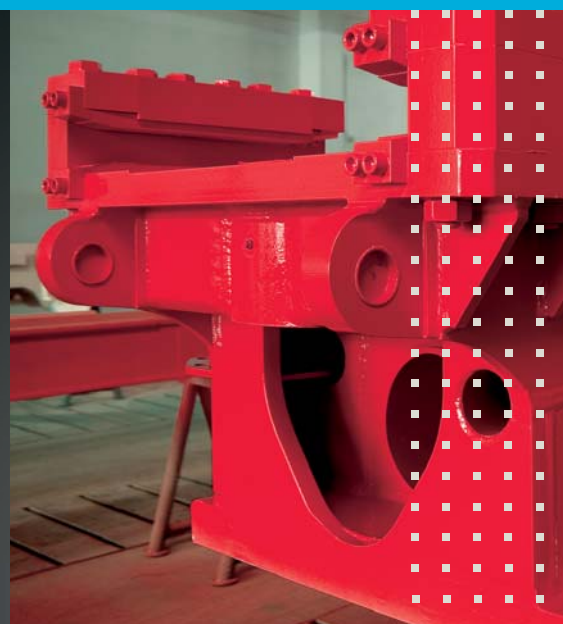

#### GA4000AC技术参数

#### GA 4000AC Technical Data

## GA 4000AC

技术参数 Technical Data	GA 4000ACIC	GA 4000ACEC
最大油漆压力 Max. material pressure	250 bar / 3625 psi	250 bar / 3625 psi
最大空气压力 Max. air pressure	6 bar / 90 psi	6 bar / 90 psi
开关速度 Trigger speed (open & close)	50 ms	50 ms
重量 (枪体) Weight (gun body)	481 g	424 g
重量 (完整配置) Weight (ready to spray*)	710 g	710 g
油漆接口尺寸 Material connection	G 1/2"	G 1/2"
空气接口尺寸 Air connection	G 1/4"	G 1/4"
最高油漆温度 Max. material temperature	80 °C / 176 °F	80 °C / 176 °F
油漆接口尺寸 Wetted parts	Stainless steel	Stainless steel
尺寸 (枪体) Dimensions (gun body)	114 / 47 / 45 mm	100 / 45 / 45 mm
尺寸 (预喷) Dimensions (ready to spray*)	129 / 47 / 59,5 mm	115 / 45 / 59,5 mm

\* 尺寸 (包含枪体, 底座, 空气帽和喷嘴) Includes gun body, base plate, aircap and nozzle

### 瓦格纳高压双隔膜泵, 无应用限制

瓦格纳气动高压双隔膜泵适用于空气辅助喷枪, 压力达到250巴。液体部分与外界大气完全隔离。没有摩擦, 最小剪切以及几乎没有脉冲的优点使其可以应用任何油漆和任何的喷涂设备。超长寿命确保过程可靠性。适用水性或者溶剂型油漆, UV和敏感油漆。

如您需要详细的Cobra信息, 请浏览我们的网站 [www.wagner-group.com](http://www.wagner-group.com)

### WAGNER Cobra® - No application limits

WAGNER Cobra® is a high pressure double diaphragm pump suitable for AirCoat applications up to 250 bar. The pump is completely sealed from the external atmosphere. The absence of friction, the minimum of shear and almost no pulsation make it perfect for virtually any material and application! An extremely long lifetime guarantees a high process reliability. Suitable up to 5 l/min and ideal for water- and solvent based paints, UV and reactive materials.

For further information about the WAGNER Cobra® please look in the brochure or visit us at [www.wagner-group.com](http://www.wagner-group.com)



## 手动空气辅助喷枪

瓦格纳手动空气辅助喷枪结合了出色的喷涂质量，高可靠性和人体工学设计，操作完美。瓦格纳手动空气辅助喷枪是市场上最轻的枪，扳机轻巧，日常工作更加轻松。



## Manual AirCoat guns

The WAGNER manual AirCoat guns combine excellent finishing quality, high reliability and a human engineered design for perfect handling. The WAGNER manual AirCoat guns are the lightest guns on the market and have less trigger and holding force which make daily work much easier.



高压柱塞泵 High pressure piston pumps

## 瓦格纳破冰马达柱塞泵 WAGNER IceBreaker®

瓦格纳破冰马达柱塞泵是使用任何高压喷涂应用设备的理想选择，其具备出色的耐用性，高可靠性和独特功能。高效率的空气马达确保流畅的操作和无暇的喷涂质量。泵的种类广泛，可以成功地满足小型作业以及产业型作业的需要，可使用水性和溶剂性油漆。

Outstanding durability, very high reliability and unique features make the WAGNER IceBreaker piston pumps the optimal choice for almost any high pressure application. High efficiency air motors ensure smooth operation and impeccable coating results. The wide pump range enables the unit to successfully meet the needs of small workshops as well as those of big industries. The pumps are ideal for applying water- and solvent based paints.

## 型号齐全的双组份系统

瓦格纳提供多种双组份设备。具备多功能的Twin-Control双组份设备可以混合一种颜色，一种固化剂，一种溶剂。双组份家族具备其他的功能例如，自动换色，储存配方，外围设备接口，混合精度非常高，高/低压喷涂等。

## A complete range of 2K systems

WAGNER offers a wide range of 2K systems. TwinControl - 1 color / 1 hardener / 1 solvent include all features required to mix the material. The FlexControl family offers additional features such as automatic color changes, recipe storage, peripheral equipment interfaces, and low and high pressure applications with a very high mixing accuracy.



[www.wagner-group.com](http://www.wagner-group.com)

如您需要了解更加详细的信息，请向我们索取Wagner选项目录。

Further information on GA 4000AC and on a wide variety of accessories like air caps, nozzles and hoses can be found in the WAGNER liquid applications catalog.

